

CASCADE™

TEK

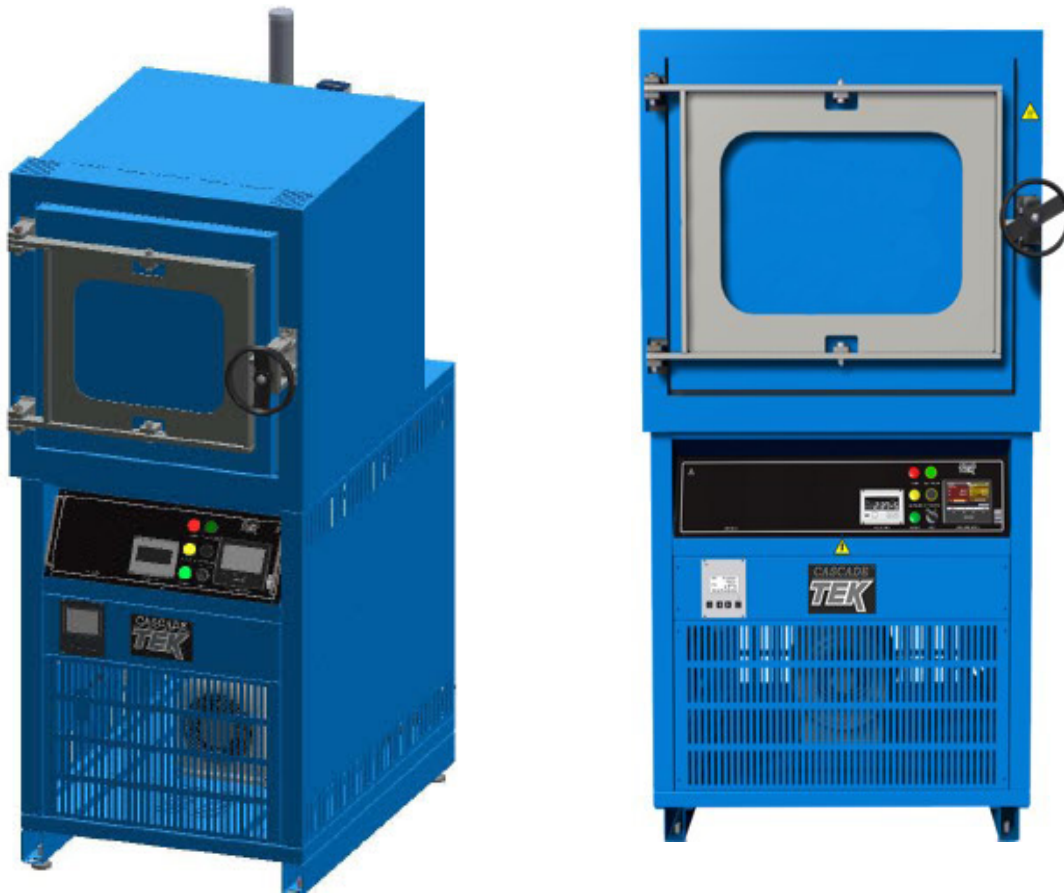

Turbo Vacuum Ovens SVO-5-T SVO-10-T
Installation and Operation Manual

Pictured on Front Cover, Left to Right: SVO-5-T, SVO-10-T

These ovens require permanent connect wiring (also known as hardwiring) to a power supply.



Warning: This product contains chemicals, including triglycidyl isocyanurate, known to the State of California to cause cancer as well as birth defects or other reproductive harm. For more information, go to www.P65Warnings.ca.gov.

¡Advertencia! Este producto contiene sustancias químicas, incluido el triglicidil isocianurato, que el estado de California sabe que causa cáncer, así como defectos de nacimiento u otros daños reproductivos. Para obtener más información, visite www.P65Warnings.ca.gov.

Avertissement! Ce produit peut vous exposer à des produits chimiques, dont l'isocyanurate de triglycidyle, reconnu par l'État de Californie pour provoquer le cancer, des anomalies congénitales ou d'autres problèmes de reproduction. Pour plus d'informations, visitez le site www.P65Warnings.ca.gov.

Turbo Vacuum Ovens 220 – 240 Voltage

Part Number (Manual): 4861814

Revision: March 14, 2025

Cascade TEK Part ID Numbers:

Model Name	SVO-10-T	SVO-5-T
Part ID	CTVT1022-H	CTVT522-H

The Part ID denotes the build type of the model. Cascade TEK periodically releases new build types of these models incorporating new features and refinements of existing ones.

Cascade TEK Solutions, LLC is an ISO 9001 certified manufacturer.

TABLE OF CONTENTS

MODEL CERTIFICATIONS	7
<i>Safety Certifications</i>	7
INTRODUCTION	9
<i>Read this Manual</i>	9
<i>Safety Considerations and Requirements</i>	9
<i>Contacting Assistance</i>	11
<i>Manufacturing Warranty</i>	11
<i>Engineering Improvements</i>	11
<i>Roughing Vacuum Pump Options</i>	12
<i>Compressed Air Supply Required</i>	12
<i>Gasket Chemical Vulnerabilities</i>	12
RECEIVING YOUR OVEN	13
<i>Inspect the Shipment</i>	13
<i>Orientation Images</i>	14
<i>Dimension Visuals</i>	17
<i>Record Data Plate Information</i>	19
INSTALLATION	21
<i>Hardwire Requirement</i>	21
<i>Installation Procedures Checklist</i>	21
<i>Required Ambient Conditions</i>	22
<i>Required Clearances</i>	22
<i>Power Source Requirements</i>	23
<i>Lifting and Handling</i>	24
<i>Leveling</i>	24
<i>Install the Oven</i>	24
<i>Disengage the Roughing Pump Locks</i>	25
<i>Installation Cleaning</i>	26
<i>Shelving Installation</i>	27
<i>Connect Gas Supplies</i>	28
<i>Vent the Roughing Pump Exhaust</i>	29
<i>Verify the Oven Chamber is Empty</i>	30
<i>Hardwire the Oven to Its Power Supply</i>	30
GRAPHIC SYMBOLS	31
CONTROL OVERVIEW	33
OPERATION	39
<i>Operating Precautions and Hazards</i>	39
<i>Theory of Operation</i>	42
<i>Put the Oven into Operation</i>	45
<i>Logging In and Out</i>	46
<i>File Export and Import</i>	47
<i>Set the Oven Limit (OTP) Temperature</i>	48
<i>Latch the Oven Chamber Door</i>	49
<i>Pump Down the Oven Chamber</i>	50
<i>End the Pump Down Process</i>	51
<i>Backfill the Chamber</i>	51
<i>Setting a Constant Temperature Setpoint</i>	52
<i>Heating Profiles</i>	53
<i>Oven Limit Active</i>	54
<i>Data Ports</i>	56
<i>Oven Cooldowns</i>	56

OPERATOR MAINTENANCE	57
<i>Cleaning.....</i>	<i>57</i>
<i>Maintaining Atmospheric Integrity.....</i>	<i>58</i>
<i>Gaskets.....</i>	<i>58</i>
<i>Electrical Components.....</i>	<i>58</i>
<i>Storage.....</i>	<i>58</i>
UNIT SPECIFICATIONS	59
<i>Weights.....</i>	<i>59</i>
<i>Dimensions.....</i>	<i>59</i>
<i>Capacity.....</i>	<i>59</i>
<i>Shelf Capacity by Weight.....</i>	<i>60</i>
<i>Vacuum.....</i>	<i>60</i>
<i>Temperature.....</i>	<i>60</i>
<i>Power.....</i>	<i>61</i>
REPLACEMENT PARTS LIST.....	63



MODEL CERTIFICATIONS

Model Certification and Compliance Statements

SAFETY CERTIFICATIONS

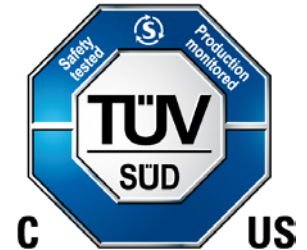

61010 Safety Certified

Electrical, mechanical, and fire hazards

The unit models in this manual are CUE listed by TÜV SÜD America as vacuum ovens for professional, industrial, or educational use in conditions in which no flammable, volatile, or combustible materials are being heated and the unit is being operated under an environmental air pressure range of 22.14 – 31.3 inHg (75 – 106 kPa).

These models have been tested to the following requirements:

CAN/CSA C22.2 No. 61010-1:2012/A1:2018

CAN/CSA C22.2 No. 61010-2-010:2015

UL 61010-1:2012/R:2018-11

UL 61010-2-010:2015

EN 61010-1:2010/A1:2019

EN 61010-2-010:2014

TÜV SÜD America, Inc. is a Standards Council of Canada accredited certification body, an OSHA-recognized NRTL, and an EU Notified Body.

CE Compliant

These unit models meet all required EU EMC, low-voltage, and RoHS directives.





INTRODUCTION

Thank you for purchasing a Cascade TEK oven. We know you have many choices in today's competitive marketplace when it comes to constant temperature equipment. We appreciate you choosing ours. We stand behind our products and will be here if you need us.

READ THIS MANUAL

Failure to follow the guidelines and instructions in this user manual may create a protection impairment by disabling or interfering with the unit safety features. This can result in injury or death.

Before using the unit, read the manual in its entirety to understand how to install, operate, and maintain the unit in a safe manner. Ensure all operators are given appropriate training before the unit begins service.

Keep this manual available for use by all operators.

SAFETY CONSIDERATIONS AND REQUIREMENTS

Follow basic safety precautions, including all national laws, regulations, and local ordinances in your area regarding the use of this unit. If you have any questions about local requirements, please contact the appropriate agencies.

SOPs

Because of the range of potential applications, this unit can be used for, the operator or their supervisors must draw up a site-specific standard operating procedure (SOP) covering each application and associated safety guidelines. This SOP must be written and available to all operators in a language they understand.

Intended Applications and Locations

SVO vacuum ovens are engineered for drying, curing, and baking applications under vacuum in professional, industrial, and educational environments. The ovens are not intended for use at hazardous or household locations.

Power

Your unit and its recommended accessories are designed and tested to meet strict safety requirements.

- Always hardwire the unit power feed to a protective earth-grounded electrical source that conforms to national and local electrical codes. If the unit is not grounded, parts such as knobs and controls can conduct electricity and cause serious injury.
- Position the unit so operators can quickly and easily disconnect or uncouple the power feed in the event of an emergency.
- Avoid damaging the power feed. Do not bend it excessively, step on it, or place heavy objects on it. A damaged power feed can easily become a shock or fire hazard. Never use a power feed if it has been damaged or altered in any way.

INTRODUCTION

- Use only approved accessories. Do not modify system components. Any alterations or modifications to your oven not explicitly authorized by the manufacturer can be dangerous and will void your warranty.

INTRODUCTION

CONTACTING ASSISTANCE

Phone hours for Customer Support are 6 am – 4:30 pm Pacific Coast Time (west coast of the United States, UTC -8), Monday – Friday. Please have the following information ready when calling or emailing Customer Support: the **model number**, **serial number**, **part number**, and **part ID** (see page 19).

support@cascadetek.com
888-835-9250
971-371-4096

Manufacturing and Customer Support

Cascade TEK Solutions, LLC
300 N. 26th Ave.
Cornelius, OR 97113
USA

MANUFACTURING WARRANTY

For information on your warranty and online warranty registration please visit:

<https://www.cascadetek.com/warranty/>

ENGINEERING IMPROVEMENTS

Cascade TEK continually improves all of its products. As a result, engineering changes and improvements are made from time to time. Therefore, some changes, modifications, and improvements may not be covered in this manual. If your unit's operating characteristics or appearance differs from those described in this manual, please contact your Cascade TEK dealer or customer service representative for assistance.

INTRODUCTION

ROUGHING VACUUM PUMP OPTIONS

The turbopump on the back of the oven operates in conjunction with a roughing pump in the oven pump cabinet. Both pumps are installed at the factory and come plumbed to the oven vacuum system.

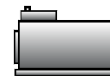

Refer to the pump manufacturer manuals shipped with the oven for specifications and compatibility with applications. Consult the manual for operating requirements and maintenance or diagnostic issues relating directly to the pump.

Shipping Locks: The roughing pump comes with built-in shipping locks to prevent damage during transit. See page 25 for instructions on disengaging the roughing pump locks prior to putting the oven into operation.

COMPRESSED AIR SUPPLY REQUIRED

Compressed air provides the pneumatic pressure needed to operate the automated vacuum and gas backfill vent valves. The oven chamber cannot be evacuated or backfilled without a compressed air supply.

Use ¼ inch OD (outside dimension) tubing to connect the supply to the ¼ inch push fitting on the back, left side of the oven, labeled Air 70 PSI.

The oven requires **70 psi** of air pressure to be delivered at the port to function. **Never exceed 80 psi.**

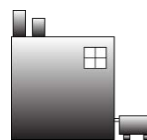
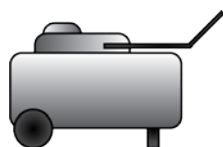
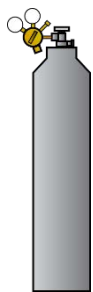

**Building
Pneumatic
Supply**

GASKET CHEMICAL VULNERABILITIES

The oven comes with a *Viton®* gasket built into the oven door. The gasket must seal against the un-nicked contact surface on the oven body in order for the oven chamber to hold vacuum.

The gasket is a low wear, long-duration component that is rated to 220°C and typically replaced only during scheduled services on the oven. However, the gasket is attacked by ketones, low molecular weight esters, and compounds containing nitros. Exposing the gasket to these may damage its integrity and require an early replacement. The gasket is a consumable component and is not covered under the manufacturer warranty.

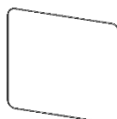

Gasket

RECEIVING YOUR OVEN

INSPECT THE SHIPMENT

Safe delivery becomes the responsibility of the carrier when a unit leaves the factory. **Damage sustained during transit is not covered by the manufacturing defect warranty.**

When you receive your unit, inspect it for concealed loss or damage to its interior and exterior. If you find any damage to the unit, **follow the carrier's procedure for claiming damage or loss.** Save the shipping carton until you are certain that the unit and its accessories function properly.

1. Carefully inspect the shipping carton for damage.
2. Report any damage to the carrier service that delivered the unit.
3. If the carton is not damaged, open the carton and remove the contents.
4. Inspect the unit for signs of damage. See the orientation depiction on the next page as a reference.
5. The unit should come with an operator Installation and Operation Manual, a profile programming guide, a user manual for the vacuum display, and a manufacturer vacuum pump manual.
6. Verify the correct number of accessory items has been included.
7. Carefully check all packaging for accessories before discarding.

Included Accessories:

SVO-10-T	Leveling Feet	Shelf	Shelf Clip
	4	3	18

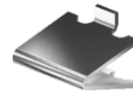

SVO-5-T	Leveling Feet	Shelf	Shelf Clip
	4	3	18

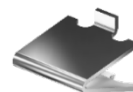

RECEIVING

ORIENTATION IMAGES

SVO-10-T Control Panel

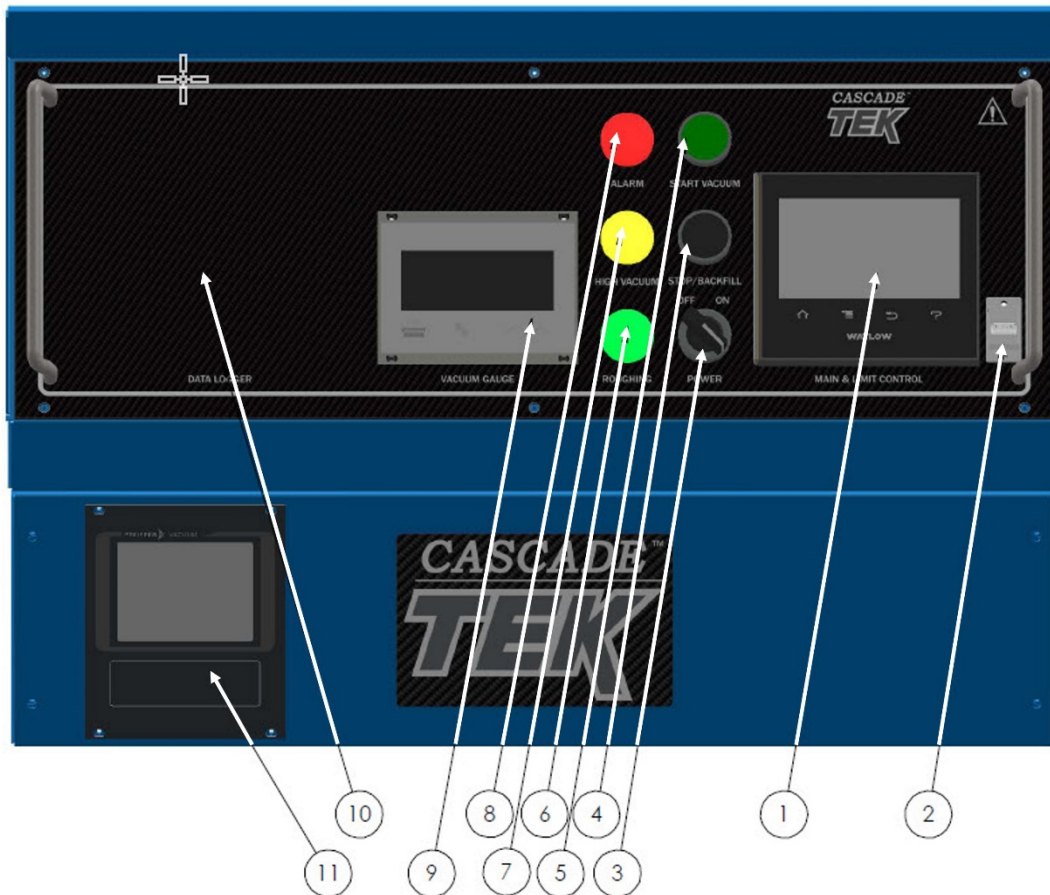

Item	Description
1	Watlow F4T Process Controller
2	Watlow F4T USB
3	Power Selector Switch
4	Stop/Backfill Push-Button
5	Start High-VAC Push-Button
6	Roughing-Stage Indicator Light
7	High VAC Indicator Light
8	Vacuum/Over Temp Alarm
9	Inficon VGC501 Vacuum Gauge Controller
10	Optional Data Logger
11	Pfeiffer Omnicontrol 001 Turbo Monitor

RECEIVING

SVO-5-T

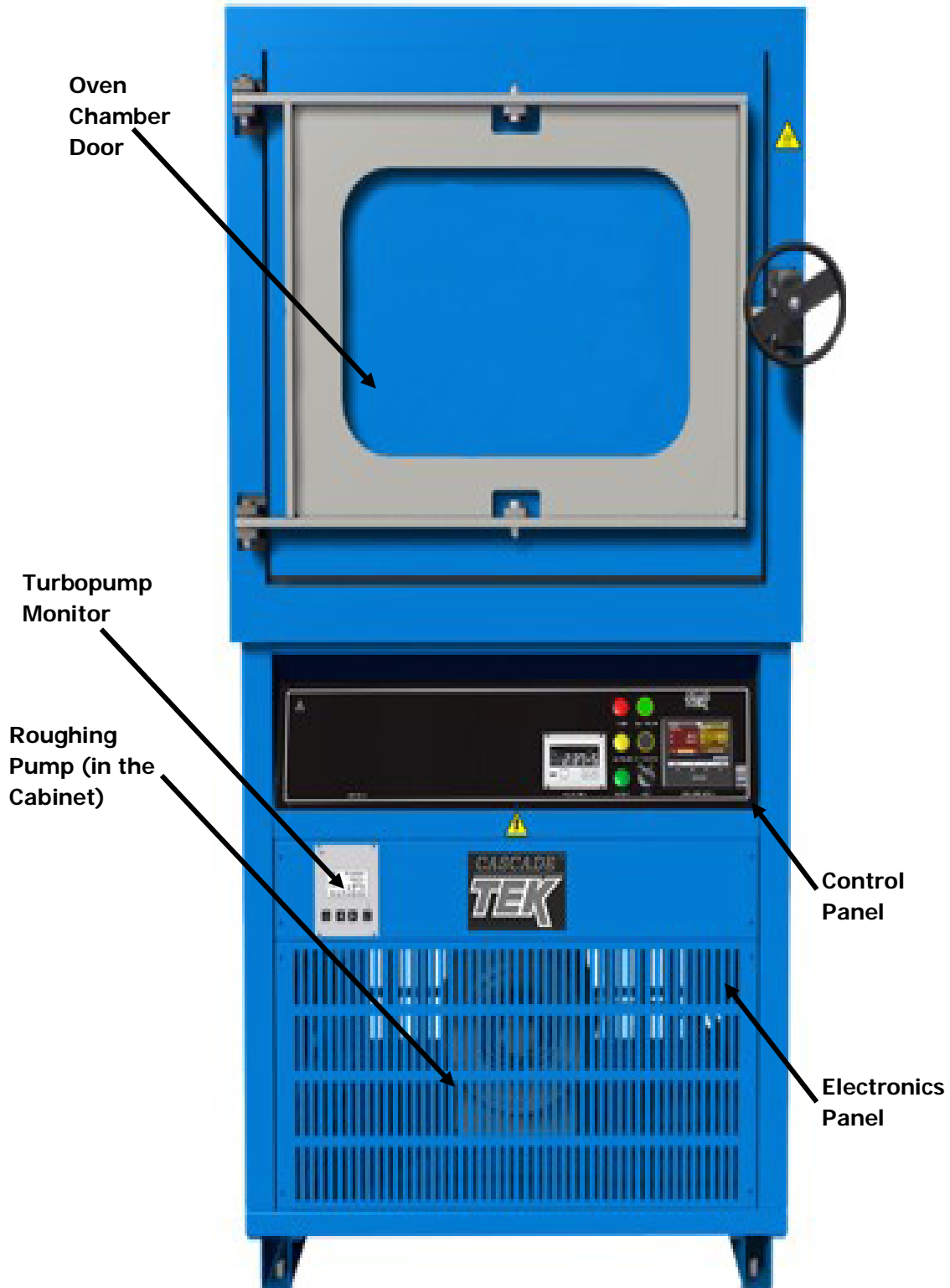

RECEIVING

Back of Oven

Foreline Gauge

Auxiliary Chamber Port (KF-25)

Backfill Valve

Compressed Air Port
1/4" (6.35 mm) Push

Backfill Intake Port
3/8" (9.5 mm)

Vacuum Exhaust Tubing
(standard pump units)

Turbopump

Foreline

Roughing Vacuum Valve

Hardwire Power Feed
(Shipping Cover Pictured)

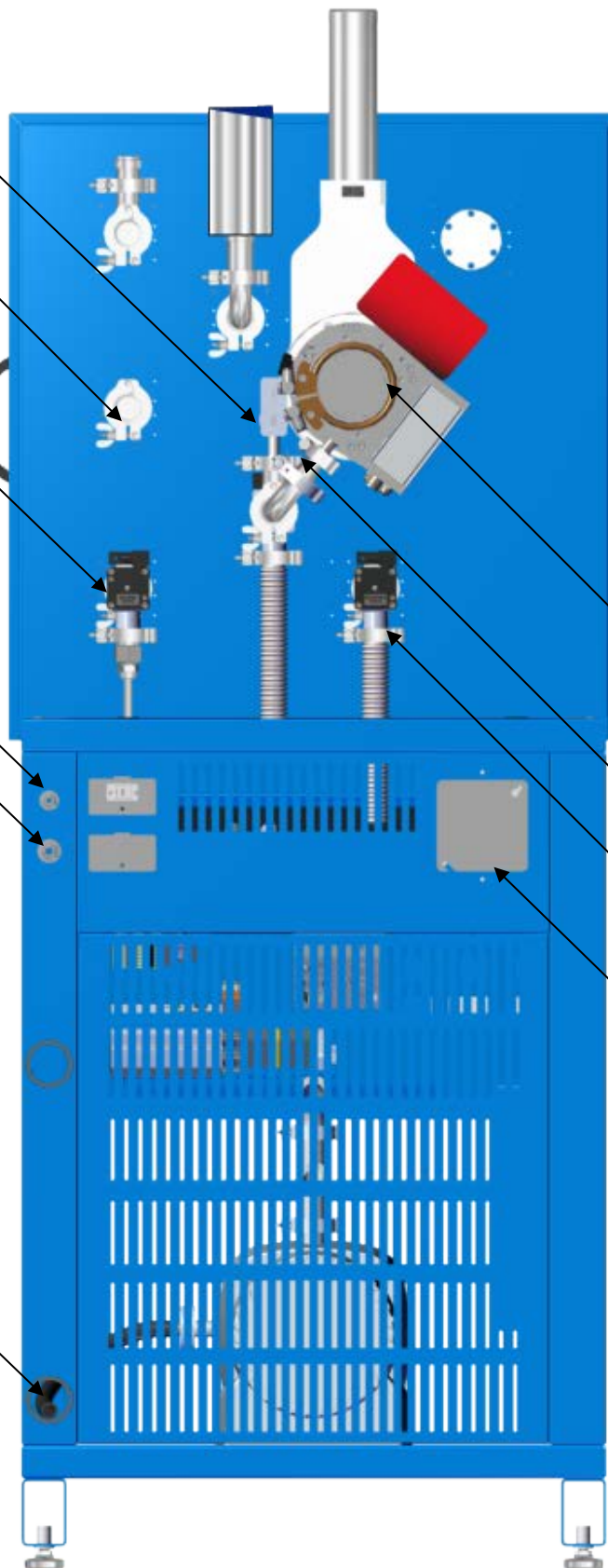

RECEIVING

DIMENSION VISUALS

SVO-10-T

Shown with optional viewing window.

Height: 75.8 inches (1925 mm)

Depth: 52.9 inches (1343 mm)



Exterior

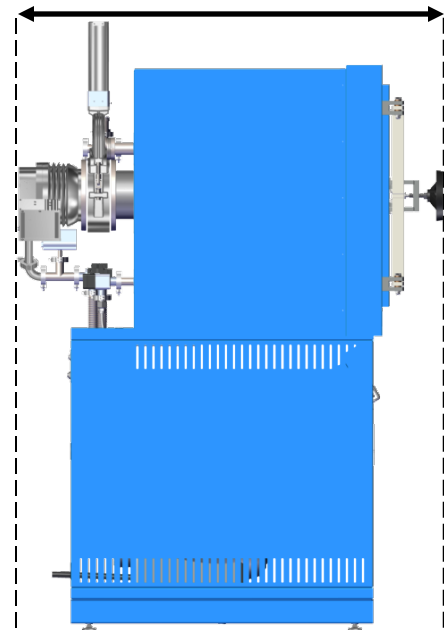

Width: 38.7 inches (983)

Chamber Height: 24.5 inches (622 mm)

Chamber Depth: 26.0 inches (660 mm)

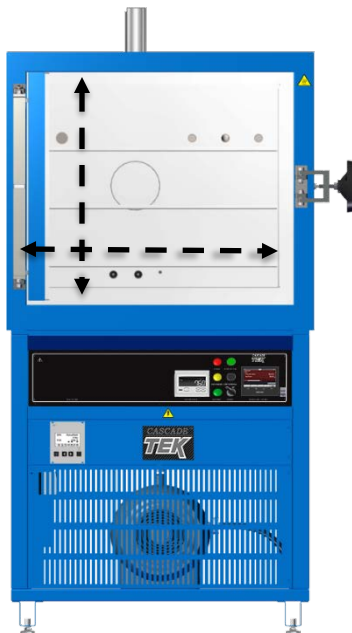

Interior

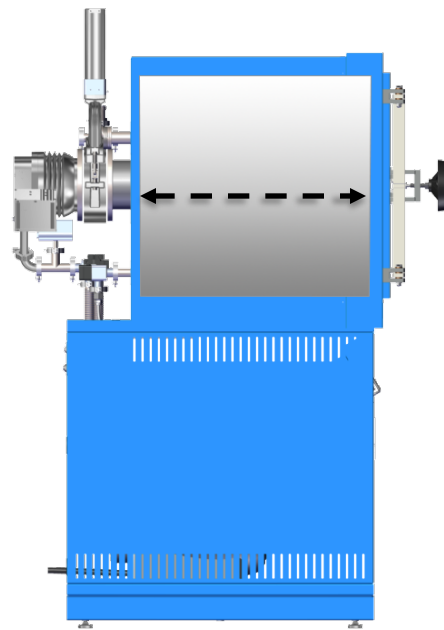

Chamber Width: 28.8 inches (730 mm)

Shelf Depth: 25.0 inches (635 mm)

Shelf



Shelf Width: 28.2 inches (718 mm)

RECEIVING

SVO-5-T

Height: 69.2 inches (1758 mm)



Width: 28.8 inches (732 mm)

Chamber Height: 18.0 inches (457 mm)

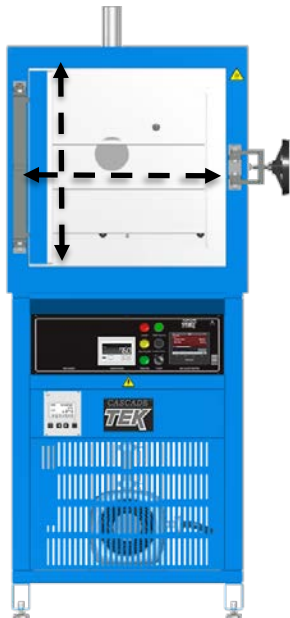

Chamber Width: 18.0 inches (457 mm)

Exterior

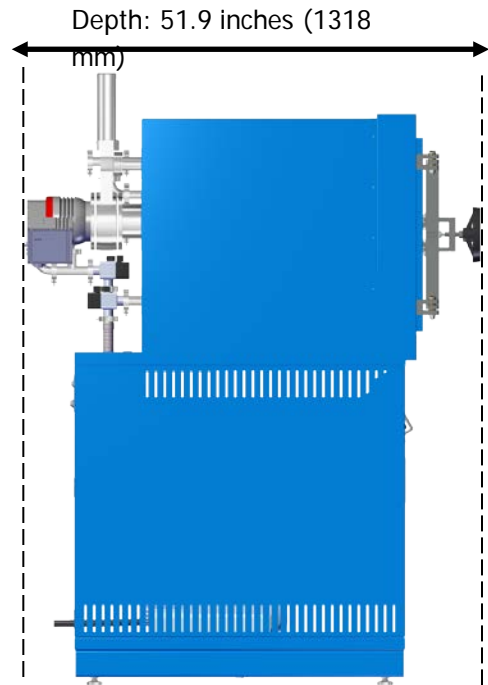

Depth: 51.9 inches (1318 mm)

Chamber Depth: 26.0 inches (660 mm)

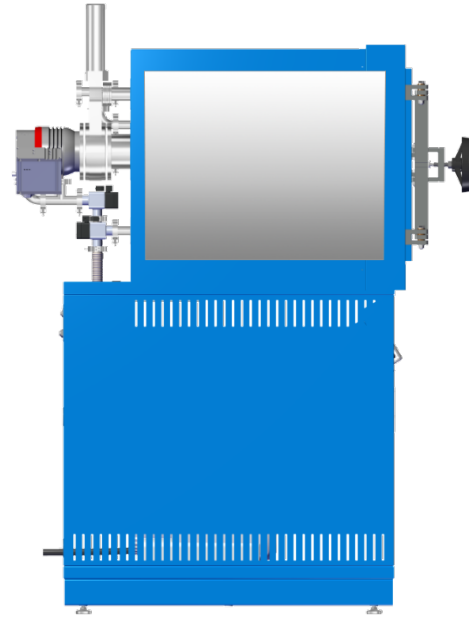

Interior

Shelf



Shelf Width: 17.5 inches (444 mm)

Shelf Depth: 25.0 inches (635 mm)

RECORD DATA PLATE INFORMATION

The data plate contains the unit **model number**, **serial number**, **part number**, and **part ID**. Customer Support will need this information during any support call. Record it below for future reference.

- The data plate is located on the back, right side of the oven, above the compressed air inlet port.

MODEL NO:	
SERIAL NO:	
PART NO:	
PART ID:	



INSTALLATION

HARDWIRE REQUIREMENT

The oven requires permanent connect wiring (commonly known as hardwiring). Wiring to the power source **must be performed by a qualified electrical technician**. All other installation steps may be performed by the operator.

INSTALLATION PROCEDURES CHECKLIST

For installing the unit in a new workspace location.

Pre-Installation

- ✓ Verify that a compressed air supply is available and can be connected to the oven. See page 12.
- ✓ Check that the required ambient conditions for the unit are met, page 22.
- ✓ Check that the spacing clearance requirements are met, page 22.
 - Unit dimensions may be found on page 59.
- ✓ Check that a suitable permanent connect power supply is present, page 24.

Install the oven in a suitable location

- ✓ Review the lifting and handling instructions, page 25.
- ✓ Install the unit leveling feet, page 25.
- ✓ Install the oven in its workspace location, page 24.

Set up the oven for use

- ✓ Disengage the roughing pump locks, page 25.
- ✓ Clean the chamber and shelving, page 26.
- ✓ Install the shelving in the oven chamber, page 27.
- ✓ Connect the oven to its pressurized air supply source along with any optional backfill gas supply, page 28.
- ✓ Connect the oven vacuum pump exhaust to a ventilation system to remove outgassed byproducts from the workspace area, page 30.
- ✓ Verify the chamber is empty and clean, page 31.
- ✓ Hardwire the oven to its power supply, page 30.

INSTALLATION

REQUIRED AMBIENT CONDITIONS

These units are built for use indoors, at room temperatures between **15°C and 35°C (59°F and 95°F)**, at no greater than **80% Relative Humidity** (at 25°C / 77°F). The ambient temperature should not change by 2°C (3.6°F) or more during operation.

Operating outside these conditions may affect the oven temperature performance.

When selecting a location to install the unit, consider all environmental conditions that can adversely impact its temperature performance. These include:

- Proximity to other ovens, autoclaves, and any device that produces significant radiant heat
- Heating and cooling vents or other sources of fast-moving air currents
- High-traffic areas
- Direct sunlight

REQUIRED CLEARANCES

These clearances are required to provide airflows for ventilation and cooling.

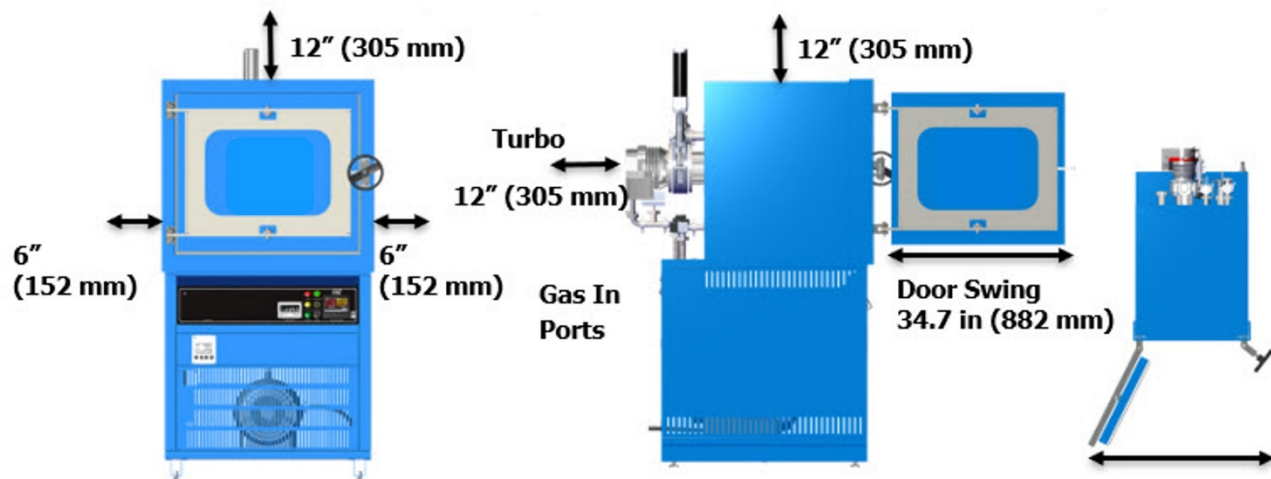

6 inches (152 mm) of clearance is required on the sides.

12 inches (305 mm) of headspace clearance is required between the top of the unit and any overhead partitions.

Do not place objects on top of the oven.

Vacuum, backfill, and access ports are located on the back of the oven. Leave sufficient clearance for operators to safely access these ports.

Leave a 130° arc for the door swing. This allows large sample trays to be removed safely from the chamber without damaging the door seal or metal sealing surfaces.

INSTALLATION

POWER SOURCE REQUIREMENTS

When selecting a location for the oven, verify each of the following requirements is satisfied:

Power Source: The power source must match the voltage and amperage requirements listed on the unit data plate.



- The ovens are intended for 50/60 Hz applications at the following amperages:

Model	AC Voltage	Amperage
SVO-10-T	220 – 240	30
SVO-5-T	110 - 120	30

- The power source must be **protective earth grounded and single phase**.
- The power source must conform to all national and local electrical codes.
- The unit may be damaged if the supplied voltage varies by more than 10% from the data plate rating.
- A dedicated separate circuit for the oven is recommended to prevent possible loss of product due to overloading or failure of other equipment on the same circuit.

Switch or circuit-breaker: A wall switch or circuit-breaker must be used in the building installation to protect against overcurrent conditions.

- Recommended circuit-breaker for the wall power source for both units is **30 amps**.

Power Feed Disconnect: The oven must be positioned so that all operators have access to the power feed disconnect in case of emergencies.

- The disconnect must be near the equipment and within easy reach of the operator.
- The disconnect must be marked as the disconnecting device for the equipment.

Internal Circuit Breakers: The oven comes equipped with multiple internal circuit breakers. Resetting these is a **service-level procedure**. The cause of the overcurrent conditions that tripped the breakers must be identified and repaired prior to resetting.

INSTALLATION

LIFTING AND HANDLING

The oven is heavy. Use appropriate lifting devices that are sufficiently rated for these loads. Follow these guidelines when lifting the oven:

- Lift the oven only from its bottom surface.
- Doors, handles, and knobs are not adequate for lifting or stabilization.
- Restrain the oven completely while lifting or transporting so it cannot tip.
- Remove all moving parts, such as shelves and trays, and lock doors in the closed position during transfers to prevent shifting and damage.

LEVELING

Install the 4 leveling feet in the corner holes in the bottom of the unit. The unit must be level and stable for safe operation.

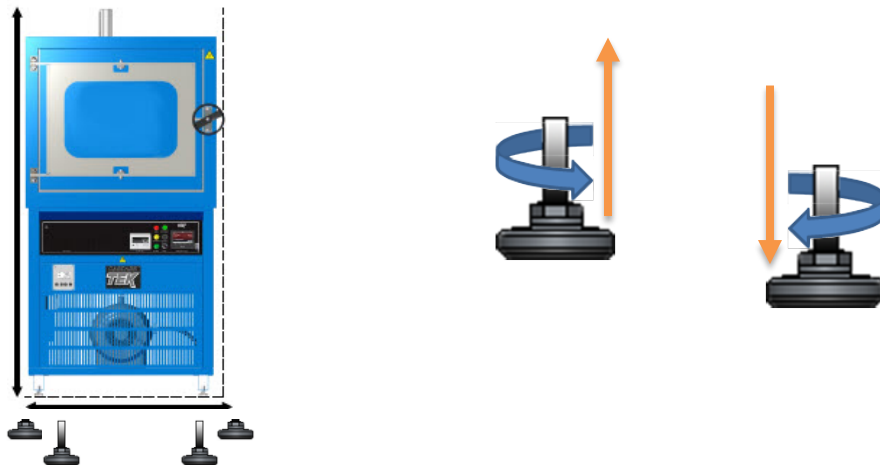

Note: To prevent damage when moving the unit, turn all 4 leveling feet so that the leg of each foot sits inside the unit.

INSTALL THE OVEN

Install the unit in a workspace location that meets the criteria discussed in the previous entries of the Installation section.

- **Do not connect the oven to its power source at this time.**

INSTALLATION

Note: The manufacturer recommends that this procedure be performed by a qualified electrical technician. The oven should remain disconnected from its power source throughout the procedure.

DISENGAGE THE ROUGHING PUMP LOCKS

The oven roughing pump has four internal shipping locks on its base to cinch it to the floor of the electronics cabinet. This prevents damage from impacts or shifting during transit. The locks must be disengaged prior to placing the oven into operation. If the locks remain engaged, vibrations from the vacuum pump can cause the oven to rattle and may speed the wear of the turbopump.

Required Tools:

- A Phillips Screwdriver
- T-Handle Allen Wrench (Included in the roughing pump document package)

1. Use the Phillips screwdriver to remove the front and back cabinet access panels.



2. One at a time, insert the Allen wrench into each lock access port on the roughing pump.

- The 4 ports are indicated by labels below each port.
- The order of disengaging the locks does not matter. Begin with any of the ports.

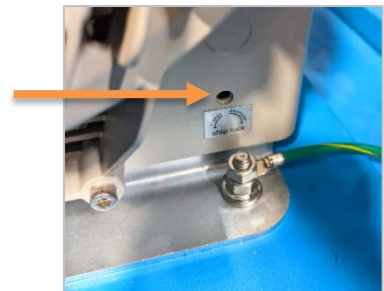

3. Turn the Allen wrench to the right until each lock spins freely. This disengages the locks. Disengage all 4 locks.

- If a lock will not turn, move to another lock. Disengaging the next lock may relieve tension on the first lock, allowing it to be released.

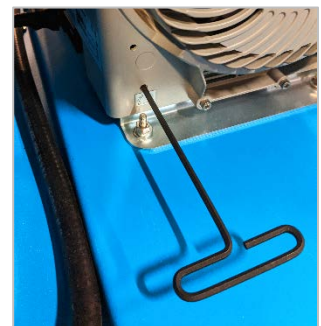

4. Once all the locks are disengaged, reinstall the front and back cabinet access panels.

INSTALLATION CLEANING

The manufacturer recommends cleaning the shelving and oven chamber prior to installation of the shelving in the chamber. The unit was cleaned at the factory but may have been exposed to contaminants during shipping.

- Remove all wrappings and coverings from shelving prior to cleaning and installation.
- See the **Cleaning** topic in the Operator Maintenance section (see page 57) for more information on how to clean the oven chamber and shelving.
- **Do not clean with deionized water.**

INSTALLATION

SHELVING INSTALLATION

To ensure accurate temperature measurement, **one shelf bottom must be in close proximity to the oven temperature probe**. This probe extends out from the chamber back wall. Do not place the shelf in direct contact with the probe.

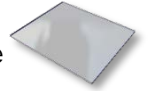

Install 6 Shelf Clips



Rocking Motion

Place the Shelf

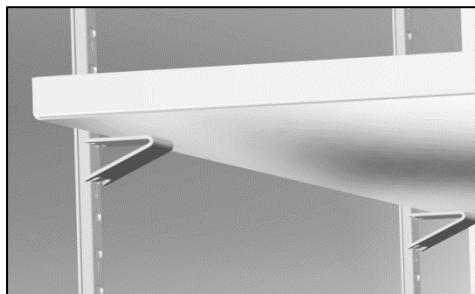

1. Install the shelf clips in the slots of the shelf standard mounting rails located on the sides of the chamber interior, 6 clips per shelf.
 - a. Squeeze each clip, insert the top tab first, and then the bottom tab using a rocking motion.
2. Set the shelves on the clips.
 - a. Verify the shelves are level.

INSTALLATION

CONNECT GAS SUPPLIES

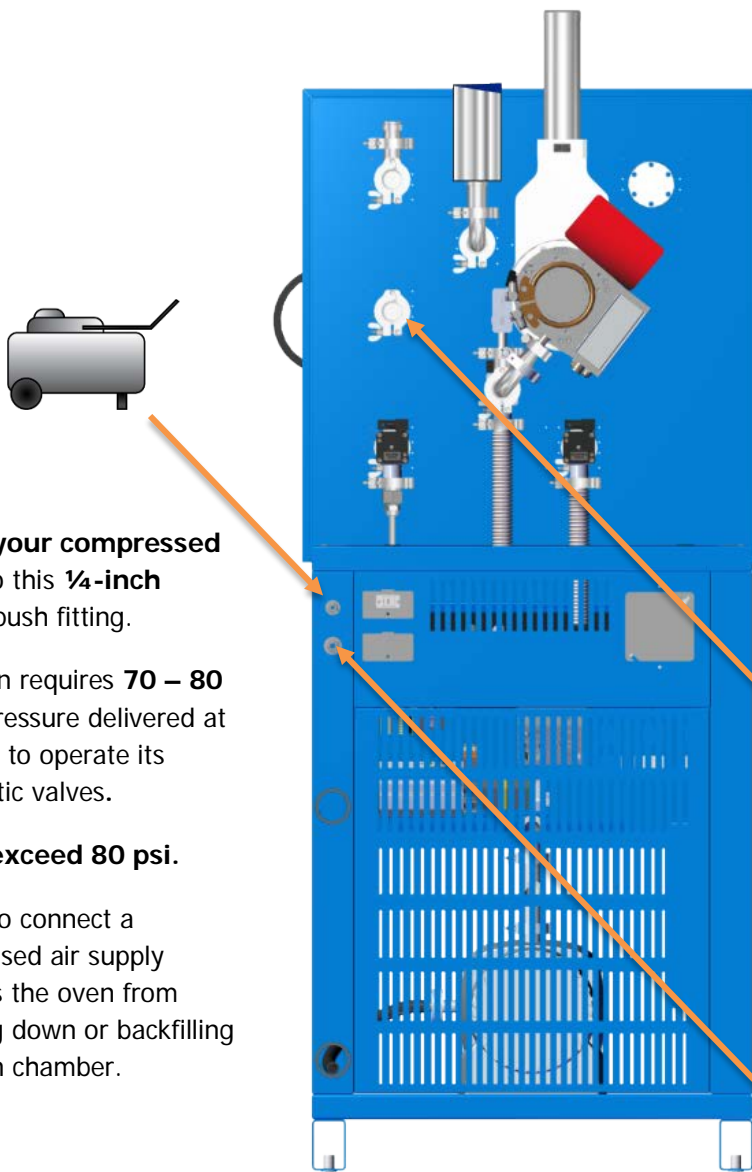

1. Connect your compressed air supply to this 1/4-inch (6.35 mm) push fitting.

- The oven requires **70 – 80 psi** of pressure delivered at this port to operate its pneumatic valves.
- **Never exceed 80 psi.**
- Failure to connect a compressed air supply prevents the oven from pumping down or backfilling the oven chamber.

Optional: Connect equipment to the KF-25 auxiliary port. Comes with a blank and clamp.

Inert Backfill Gas Supply
Optional: Connect gas nitrogen or another inert gas supply to this **3/8" (9.5 mm) push fitting** for backfilling the oven chamber.
Do not exceed 15 psi of pressure delivered at the port.

INSTALLATION

Note: Outgassed byproducts may be hazardous to or noxious for operating personnel. Vacuum pump exhaust should be vented to a location outside the workspace in a safe manner in accordance with all applicable laws, ordinances, and regulations.

VENT THE ROUGHING PUMP EXHAUST

The oven comes with a roughing vacuum pump installed in a cabinet at the base of the oven. Failure to vent the roughing pump outside of the cabinet will result in outgassed byproducts coating oven electrical systems and poses a potential hazard to oven operators.

The turbopump is mounted on the back of the oven vents to the roughing pump through the foreline.

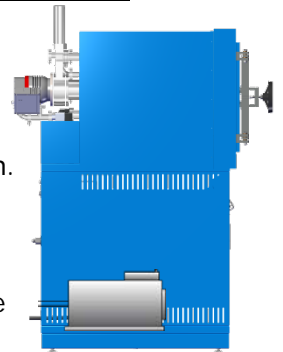

Pump Cabinet and Electronics

The cabinet housing the vacuum pump also contains high-voltage electronics and should only be accessed by a qualified electrical technician.

Exhaust Connection



½ Inch ID Hose (12 mm): Pull the hose outside the port located on the lower left side of the cabinet.

INSTALLATION

VERIFY THE OVEN CHAMBER IS EMPTY

Prior to placing the oven into operation, verify the oven chamber is clean and all shipping dunnage and any shelf wrappings have been removed.

Failure to do so may result in damage to the oven chamber interior or vacuum pumps.



HARDWIRE THE OVEN TO ITS POWER SUPPLY

The oven may now be connected to a power supply that meets the requirements on page 23.

Power Braid: Each oven comes provided with an integral 6-inch (150-mm) wire braid consisting of:

- Two 10-gauge hot wires – black, red
- One 10-gauge earth ground – green-yellow





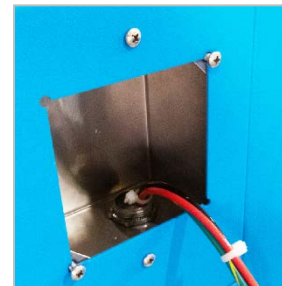

Remove the cover to expose the power wire braid. Use a Phillips-head screwdriver.



The oven must be earth grounded using the protective conductor terminal (green with yellow stripe wire). Do not remove the protective conductor (earth connection). Removing the protective conductor will negate the oven's protections against potentially dangerous electric shocks and create a potential fire hazard.

GRAPHIC SYMBOLS

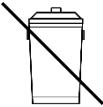
The oven is provided with multiple graphic symbols on its interior and exterior surfaces. The symbols identify hazards and the functions of the adjustable components, as well as important notes in the user manual.

Symbol	Definition
	Consult the user manual Consulter le manuel d'utilisation
	AC Power Repère le courant alternatif
	Potential shock hazard Risque de choc électrique
	Recycle the unit. Do not dispose of in a landfill Recycler l'unité. Ne jetez pas dans une décharge
	Protective earth ground Terre électrique
	Caution Hot Surface Attention surface chaude

This page left blank.

CONTROL OVERVIEW

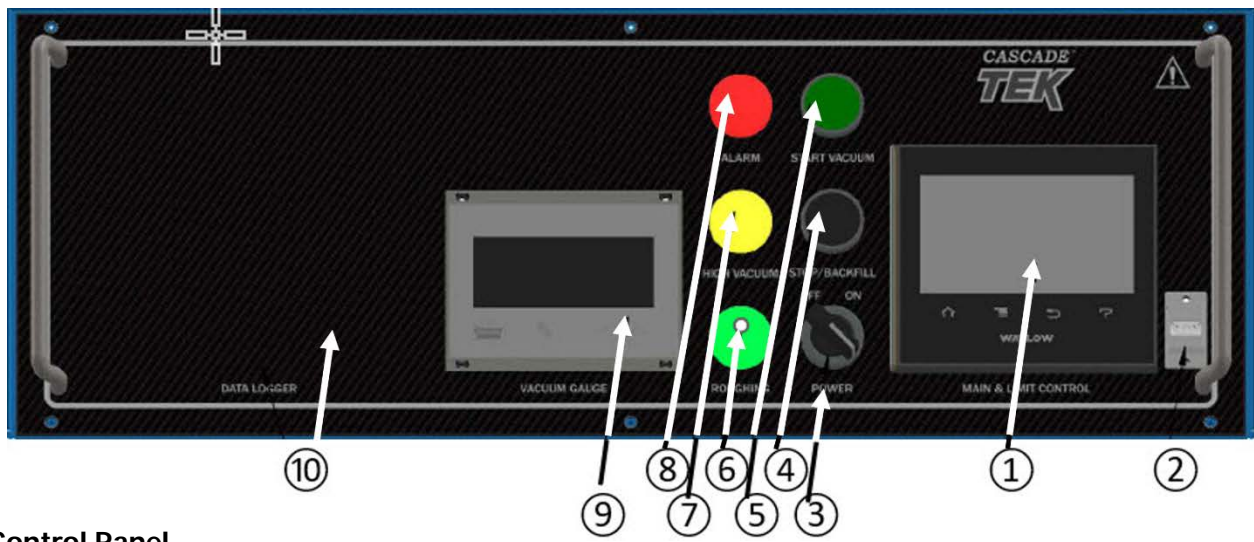

Control Panel

Item	Description
1	Watlow F4T Process Controller
2	Watlow F4T USB
3	Power Selector Switch
4	Stop/Backfill Push-Button
5	Start High-VAC Push-Button
6	Roughing-Stage Indicator Light
7	High VAC Indicator Light
8	Vacuum/Over Temp Alarm
9	Inficon VGCS01 Vacuum Gauge Controller
10	Optional Data Logger
11	Pfeiffer Omnicontrol 001 Turbo Monitor

Turbo Pump Monitor – Below Control Panel

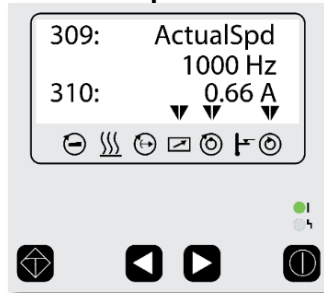

The top line displays the turbopump blade rotation speed in hertz. Hz equals the number of rotations per second.

The bottom line shows the amperage the pump is drawing. This is an indicator of how much work the pump is performing.

To change the display parameters, see the turbopump monitor user manual, which ships with the oven.

Vacuum Gauge



Shows the chamber pressure level in Torr.

To show the chamber pressure in other units of measurement, see the vacuum gauge user manual that comes included with the oven.

Alarm Light



The red alarm light activates in one of two scenarios:

- The light illuminates steadily when a temperature limit is activated.
- The light flashes when the chamber fails to reach high vacuum in 30 minutes and the oven stops pumping down.

Vacuum Pump Lights



The Turbo Vacuum light illuminates yellow when the turbopump high vacuum valve connecting the pump to the chamber is open. The oven chamber and foreline between the turbo and roughing pumps must be below 1 Torr for the valve to open.

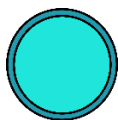

The Roughing Vacuum light illuminates blue when the roughing pump valve is open. This occurs during the initial chamber pump down to below 1 Torr or if the chamber and foreline pressure later rise above 1 Torr.

Start Vacuum

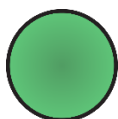

Pushing and releasing the Start Vacuum button initiates the pump down process. The oven roughing pump will pump down the oven chamber to 1 Torr, then activate the turbopump after a pause.

Stop / Backfill



Pushing and releasing the Stop / Backfill button turns off the turbopump and isolates the chamber from both the turbo and roughing pumps.

- The turbopump will begin to spin down after the button is pushed.
- The roughing pump will spend 5 minutes continuing to pump down the foreline before closing the foreline valve.

Once the chamber is isolated, pressing and holding the button backfills the oven chamber.

Power Switch

- Controls all power to the oven and its systems.

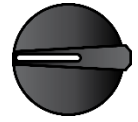

Main and High Limit Controller – Homepage

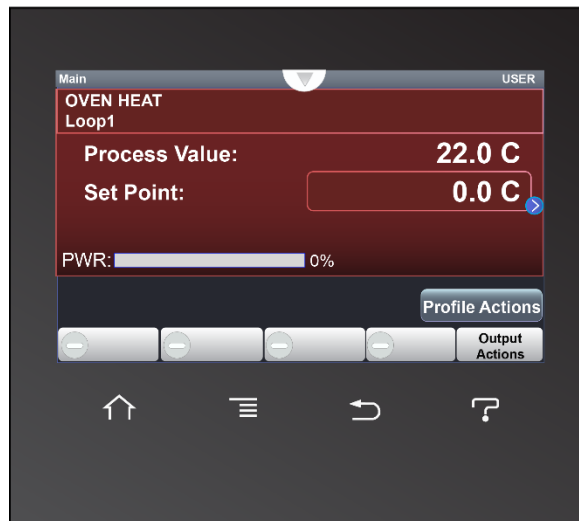

Home

Returns the display to the homepage.



Menu

Accesses the **password** for unlocking the heating profile programming menu.



Return

Returns the display to the previous page or menu.



Help

This button has no assigned functions.

CONTROLS

Oven Shelving Temperature Tab - Homepage

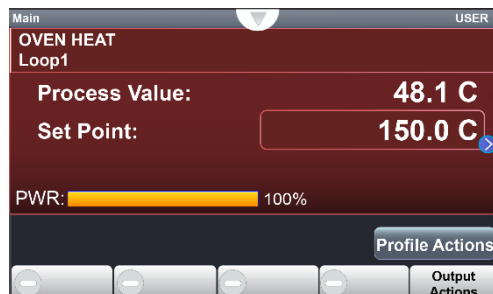

- ← The current oven chamber shelving temperature, 48.1°C
- ← A Constant Temperature Setpoint (SP) of 150.0°C entered on the setpoint button.
- ← Oven heating with 100% power (PWR)

PV (Process Value):

- When atmosphere is present in the chamber, the Process Value shows the gas temperature.
- When the oven chamber is pumped down, the Process Value shows the current chamber shelving temperature.

150.0 C

(SP) Setpoint button: A target, constant temperature the oven heats to and maintains when a profile is not running. Setting the setpoint to zero effectively gives the oven an unheated resting state.

PWR: The power bar indicates the percentage of maximum power the oven controller is calling for to heat the oven chamber.

Oven Limit (OTP) Page

The Oven Limit (OTP) system sets an independent heating cutoff temperature to help safeguard the oven in the event of a hardware failure or external event. See the Oven Limit topic on page 44 for more information.

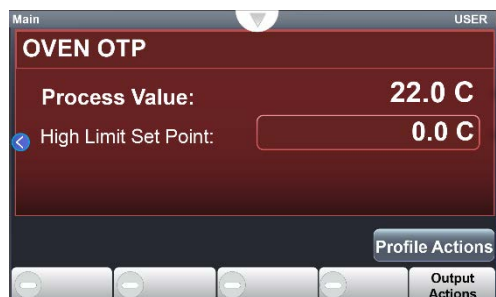

- ← The current oven temperature
- ← High temperature heating cutoff setpoint button

Output Actions

Brings up the output menu, showing each output channel and the data type assigned to it.



Profile Actions

This button brings up heating profile menu options. These include:

- Running a profile (launching).
- Creating a new profile.
- Editing an existing profile.
- Exporting profiles.



Note: You must log in to create or edit profiles. These actions are hidden when not logged in.

Right Arrow

Tapping the arrow brings up the Oven Limit page.





OPERATION

Safe operation of the oven is dependent on the actions and behavior of the oven operators. Operating personnel must read and understand the Operating Precautions in this section prior to operating the oven. The operators must follow these instructions to prevent injuries and to safeguard their health, environment, and the materials being treated in the oven, as well as to prevent damage to the oven. Failure to adhere to the Operating Precautions, deliberately or through error, is a hazardous behavior on the part of the operator.



Le fonctionnement sûr du four dépend des actions et du comportement des opérateurs du four. Le personnel d'exploitation doit lire et comprendre les consignes de sécurité et les précautions d'utilisation de cette section avant d'utiliser le four. Les opérateurs doivent suivre ces instructions pour prévenir les blessures et protéger leur santé, leur environnement et les matériaux traités dans le four, ainsi que pour éviter d'endommager le four. Le non-respect des consignes de sécurité et des précautions d'utilisation, délibérément ou par erreur, est un comportement dangereux de la part de l'opérateur.



OPERATING PRECAUTIONS AND HAZARDS

Explosions and Hazardous Materials

- Do not use this oven in unsafe improper applications that produce flammable or combustible gases, vapors, liquids, or fuel-air mixtures in quantities that can become potentially explosive.
- Outgassed byproducts may be hazardous to or noxious for operating personnel. Vacuum pump exhaust should be vented to a location outside the workspace in a safe manner in accordance with all applicable laws, ordinances, and regulations. Do not operate the oven in an unsafe area with noxious fumes.
- Do not use this oven for applications heating hazardous fibers or dust. These materials can become airborne and come into contact with hot surfaces.
- Individual ovens are not rated to be explosion-proof. Follow all building certification requirements and laws for Class I, II, or III locations as defined by the US National Electric Code.
- The bottom surface of the chamber should not be used as a work surface. It runs hotter than the shelf temperatures. Never place samples or product on the oven chamber floor.
- Do not place sealed or filled containers in the oven. These may burst open when the chamber is under vacuum.
- Do not place alcohol or mercury thermometers in the oven. With improper use, they can rupture.
- Do not move the oven until it has finished cooling.

Warning Hot Surfaces: These areas are marked with Hot Surface labels. Proper protective equipment should be employed to minimize the risk of burns.

Avertissement Surface Chaude: Ces zones sont marquées avec des étiquettes de surface chaude. Un équipement de protection approprié devrait être utilisé pour minimiser le risque de brûlures.



Turbomolecular Pump Hazards and Precautions

Fragmentation Hazards



Turbopump blades spin at tens of thousands of rotations per minute in a nearly friction-free environment with ultra-tight tolerances inside the pump housing. Catastrophic damage may result if the oven turbopump suffers a significant impact or is moved while the blades are spinning. A sudden and large internal pressure increase while spinning can also induce a catastrophic failure. The pump blades may disintegrate under these conditions, causing irreparable internal damage. In the worst failure case, blade fragments can exit the front of the pump housing, entering the oven chamber at high velocity.



Les aubes de turbopompe tournent à des dizaines de milliers de tours par minute dans un environnement presque sans frottement avec des tolérances ultra-serrées à l'intérieur du corps de pompe. Des dommages catastrophiques peuvent survenir si la turbopompe du four subit un impact important ou est déplacée pendant que les pales tournent. Une augmentation soudaine et importante de la pression interne pendant la rotation peut également provoquer une défaillance catastrophique. Les aubes de la pompe peuvent se désintégrer dans ces conditions, provoquant des dommages internes irréparables. Dans le pire des cas de défaillance, des fragments d'aubes peuvent sortir par l'avant du boîtier de la pompe et pénétrer dans la chambre du four à grande vitesse.

Possible causes for catastrophic pump failure include:

- Subjecting the oven or pump to severe external impacts or strong periodic vibrations or moving the oven while the pump blades are in motion.
- Using the oven for improper applications that generate abrupt gas pressure increases or otherwise undermine the integrity of the turbopump. These include:
 - Pumping dust or liquids through the pump
 - Pumping corrosive or explosive media through the pump
 - Attempting to pump vapors that will condense inside the pump
- Operating the pump in an ambient environment with potentially explosive airborne particulates, vapors, or gases.
- Introducing free atmosphere into the pump while spun up.
- Using the pump in an area with strong magnetic fields or ionizing radiation.
 - These may adversely affect the pump drive or directly destabilize the moving blades inside the pump housing.

Modifying the turbopump or its controllers or altering the factory settings for pump or safety interlock operations.

Continued next page

Precautions

- Do not shut off the oven while the turbopump is running. The sudden deceleration can lead to damage to the pump or other systems.
- Do not use the oven for any of the improper application types listed above.
- Do not use the oven in hazardous environments, including those listed above.
- Do not move the oven until the pump blades have stopped rotating. **It takes approximately 30 minutes for the blades to come to a complete stop** after the Stop/Backfill button is pushed.
- Never modify the oven safety setting parameters or safety interlock hardware systems.
- Do not modify or tamper with the stainless-steel clamps attaching the turbopump to the oven. An improperly secured pump is at risk of catastrophic internal failure or violent detachment from the oven.

Pump Safety Interlocks

If the oven roughing pump does not successfully pump down the oven chamber to 1 Torr within 30 minutes, the turbopump **will not** activate and the red alarm light on the control panel will flash on and off.

Additionally, the SVO comes with safety overrides that shut down the turbopump in the event of the following:

- Excessive rotational blade speeds.
- If the chamber pressure exceeds 2 Torr.
- If the pressure in the foreline pump exhaust exceeds 4 Torr.
- The safety overrides cannot protect the pump if the pump is at full rotational speed and is suddenly exposed to free atmosphere.

Contamination

The turbopump is intended for use in clean applications. Using the pump for applications that outgas oils can contaminate the interior of the pump, leading to reduced performance and possibly damaging or destroying the pump.

THEORY OF OPERATION



From Room Pressure to High Vacuum

The oven chamber is initially pumped down by a roughing pump located in the cabinet beneath the chamber. The roughing pump runs continuously while the oven is powered, but it will not draw atmosphere from the chamber until the Start Vacuum button is pushed. When Start Vacuum is pushed, the oven controller opens a pneumatic vacuum valve on the back of the oven (right side), allowing the roughing pump to begin pumping down the chamber.

The oven chamber temperature displayed on the controller homepage will fluctuate when the chamber begins pumping down. This reflects the chamber probe transitioning from measuring air temperature to the initial chamber vacuum temperature, followed by a redistribution of thermal energy in the newly established vacuum. This typically presents as a drop in temperature followed by an apparent rise. The measured drop may take place even when the chamber is actively heating.

When the chamber is pumped down to 1 Torr, the oven closes the roughing valve. It then opens a pneumatic foreline valve below the turbopump. The foreline vacuum line runs from the exhaust port on the turbopump to the foreline valve, which in turn is connected to the roughing pump. The roughing pump vacuums down the foreline to 1 Torr and will continue to run, actively holding the foreline at or below this pressure. This provides “backing” — an environment the turbopump can exhaust evacuated gas molecules into. Turbo exhaust will then pass through the roughing pump and exit the oven. Without this roughing pump backing, free atmosphere would backstream up the foreline and into the high vacuum environment of the turbopump interior.

When the foreline is pumped down, the turbopump turns on and spins up. After a pause, a high vacuum gate valve between the turbopump and the chamber opens, allowing the turbopump to begin evacuating molecular-flow gases from the chamber. This successful transition from roughing to turbo is indicated on the oven control panel by the blue Roughing Vacuum light turning off and the yellow High Vacuum light illuminating.

The ultimate obtainable vacuum level is a product of the chamber temperature and the nature of the application or process, including the volume of outgassed materials versus the maximum flow rate of the turbopump.

Vacuum Safety Interlocks

The oven is designed to isolate the turbopump from vacuum pressures higher than 1 Torr. If the roughing pump fails to pump down the oven chamber below 1 Torr in 30 minutes, the High Vacuum function will turn off, the red Alarm light will begin flashing, and the oven will cease attempting to pump down.

OPERATION

Vacuum Safety Interlocks continued

If the chamber pressure rises above 1 Torr while the turbopump is active, the oven will close the gate valve and foreline valves, isolating the pump from the chamber. The oven will then open the pneumatic roughing valve, allowing the roughing pump to vacuum down the chamber down below 1 Torr. Once pressure is under 1 Torr, the oven will pump down the foreline again, then resume turbo operations. The transitions from turbo to roughing and back to turbo are indicated by the yellow High Vacuum and blue Roughing lights on the front control panel turning off and on as the oven shifts between pumping modes.

If the oven frequently transitions back and forth between high vacuum and roughing modes, the chamber may not be properly sealed, or there may be a leak in the oven vacuum system, or the volume of outgassing from the product or contaminants in the chamber is too great to safely utilize the turbo system.

These ovens are intended solely for use in closed-cycle, under-vacuum applications.

Ending Chamber Pump Down

Pump down of the oven chamber is ended by pushing and releasing the Stop/Backfill button on the control panel.

Ending the pump down closes the roughing and high vac gate valves, leaving the oven chamber under vacuum but isolated from both pumps. The turbopump will then begin spinning down. The roughing pump will continue to pump down the foreline for 5 minutes before closing the foreline valve. This cleans the turbopump back section by allowing it to outgas into a molecular flow environment. It also helps prevent outgassed byproducts from condensing inside the foreline.

The turbopump requires approximately 30 minutes to spin down. Moving the oven or strong impacts to the pump during turbo operation or the spin-down period can catastrophically damage the pump and endanger personnel in the workspace around the oven as described in the Precautions section of this chapter.

Backfilling

Backfilling the oven chamber is initiated by pressing and holding the Stop/Backfill button until the chamber reaches room atmosphere pressure (approximately 760 Torr air / 810 Torr N₂). The backfill will not initiate for 5 seconds after the button is pressed, to ensure the gate valve is closed, protecting the turbopump.

The oven backfills using room atmosphere unless a clean or inert gas supply is connected to the push fitting Backfill/Vent port fitting on the back, left side of the oven. The maximum allowed backfill pressure is 15 psi of delivery at the port. Inert gases, such as nitrogen (N₂), are typically used to avoid oxidizing the chamber surfaces or product as well as avoid particulate contamination and introducing water vapor into the hot chamber. Clean air can also be used to avoid water and particulate contamination.



OPERATION

Temperature Modes



The oven operates in one of two heating modes: A single constant temperature setpoint or executing an operator-programmed, multistep heating profile.

Heating Control



The oven controller monitors the chamber shelving temperature using a Resistance Temperature Detector (RTD) to measure the temperature by extending the RTD into the chamber from the back wall. In a vacuum environment, the probe senses the temperature of the shelf placed immediately above it. Placement of a shelf in close proximity to, but not in contact with, the probe is crucial for an accurate measurement of the shelving temperature in the vacuum chamber.

The unit uses Proportional – Integral – Derivative (PID) control to avoid significantly overshooting the setpoint. In practice, this means the rate of heating slows as the chamber temperature approaches a target temperature. PID loops also respond to environmental conditions to optimize heating rates. If the unit is operating in a cool room, the controller will gradually increase the length of the heating pulses. Similarly, when operating in a warm room the unit will gradually use shorter heating pulses. If the ambient temperature conditions change significantly, there may be minor over or undershoots as the unit adapts.

The oven chamber is well insulated when sealed. The oven relies on natural heat radiation for cooling, and it can take days for the chamber to passively cool to ambient temperature. It can achieve a low-end operating temperature of the ambient room temperature plus the oven waste heat.

Oven Limit System



The oven controller contains a heating cutoff system with independent circuitry connected to a redundant temperature sensor probe inside the oven chamber. If the oven exceeds its current high limit setting, the Temperature Limit system routes electrical heating pulses away from the oven heating elements. A limit cutoff remains in effect until the temperature no longer exceeds the cutoff limit **and** the active limit alert is cleared by the oven operator. The alert always remains active until cleared.

The oven High Limit is set by the operator to a minimum of 10°C above the highest temperature the oven is intended to be run at during a baking application.

Note: Overriding the oven limit system voids the oven manufacturing defect warranty in the event of an overtemperature event.

OPERATION

PUT THE OVEN INTO OPERATION

Perform the following procedures and steps to place the unit into operation after installation in a new workspace environment.



✓ Turn on the oven



✓ **Optional:** Back up the oven controller.

- The manufacturer recommends backing up your oven controller configuration. See the [Logging In and Out](#) procedure on page 46 and the [File Export and Import](#) procedure on page 47.



✓ Perform the [Set the Oven Limit \(OTP\) Temperature](#) procedure on page 48.

✓ Perform the [Latch the Oven Chamber Door](#) procedure on page 49.



✓ Perform the [Pump Down the Oven Chamber](#) procedure on page 50.

- Hold the oven chamber under vacuum for **a minimum of 30 minutes** to verify the integrity of the vacuum system.



✓ Review how to set the Operating Temperatures.



- Perform the [Setting a Constant Temperature Setpoint](#) procedure on page 52, **OR**
- Program multistep [Heating Profiles](#), page 53.
- The oven chamber should always be under vacuum prior to heating.

The oven is now ready for use.

OPERATION

You must be logged in on the controller for the temperature and limit to perform the following:

- Exporting or importing configuration files
- Programming or editing profiles

Profiles can be launched, paused, or terminated without logging in.

LOGGING IN AND OUT

1. Access the Main Menu



- Tap the Menu icon

2. Login



- Tap the Login icon

3. Enter the Controller password



- Type **ctek**

Note: Ensure that the password is in all lower case.

- Tap the Enter button

You may now return to the Homepage



- Tap the Home icon

Logging Out

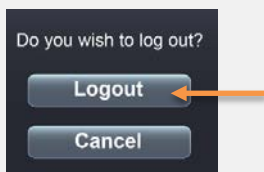
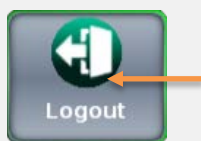

The manufacturer recommends logging out after finishing file management and profile tasks.

- Tap the Logout icon in the Main Menu
- Confirm Logout

End of Procedure

Changing the Password

The default oven password is **ctek**. The password may be changed using Watlow Composer™ software. However, Cascade TEK **cannot recover a lost password**.

OPERATION

Note: A USB must be inserted into the USB-A drive on the control panel next to the display screen to access the File Transfer menu.

FILE EXPORT AND IMPORT

The manufacturer recommends exporting the controller software configuration when first putting the oven into use. Profiles can also be imported and exported using this procedure.

1. Access the Main Menu



- Tap the Menu icon

2. Login



- See the Logging In and Out procedure on page 46.

3. Access the File Transfer Menu

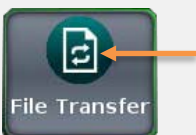

- Tap the File Transfer menu button.

4. Choose Import or Export

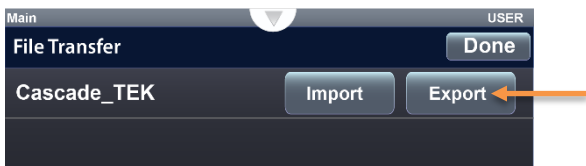

- Tap the Export button.

5. Export the Controller Configuration

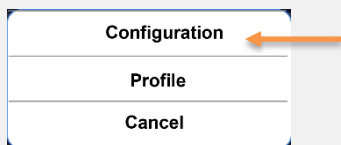

- Tap Configuration to automatically begin the file export.
- The configuration should begin downloading to the USB drive.

You may now return to the Homepage

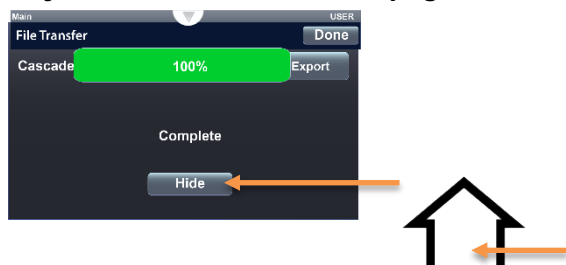

- When the export is complete, tap Hide to dismiss the export menu.
- Tap the Home icon.

End of Procedure

OPERATION



SET THE OVEN LIMIT (OTP) TEMPERATURE

Note: Test the oven limit system once per year for functionality.

Set the oven limit threshold where the independent Temperature Limit circuitry cuts off heating of the oven chamber.

Considerations when setting the oven limit cutoff:

- Set the limit prior to activating heating.
- The oven limit cutoff setpoint should be set **at least 10°C** above the highest temperature of your baking application.



1. Tap the right chevron button to bring up the Oven Limit page.
2. Tap the High Limit Set Point button.
3. Set the temperature cutoff limit
4. Return to the Homepage.

End of Procedure

OPERATION

LATCH THE OVEN CHAMBER DOOR

Ensure the oven door is securely latched before placing the chamber under vacuum.

1. Position the door handle.

- Swing the handle wheel all the way to the left, until it is facing forward.

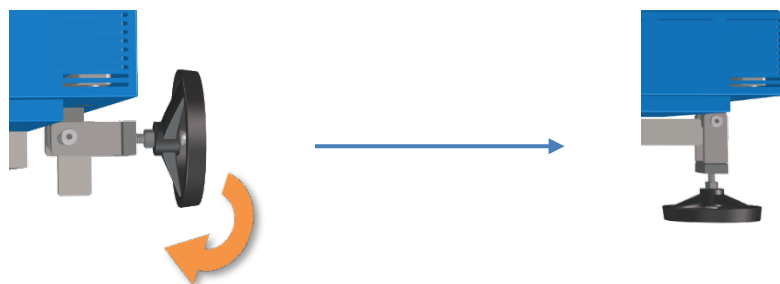

2. Secure the chamber door.

- Using one hand, turn the handle wheel clockwise (to the right) until the tongue of the handle wheel touches the hasp on the chamber body.

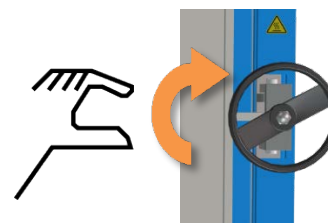

3. Tighten the handle wheel.

- Turn the wheel a **maximum of 3 more times** to tighten the door handle.
 - **Do not force or overtighten the wheel.** This can damage the door handle or latch.

4. Pump down the oven chamber to seal the door. See page 50.

5. Loosen the handle wheel after the oven chamber pressure drops below 400 Torr.

This helps safeguard against overpressurizing the chamber while backfilling.

- Turn the wheel **3 times** counterclockwise (to the left) to loosen the handle.
- Leave the handle facing forward. This prevents the door from springing open if the chamber is overpressurized.

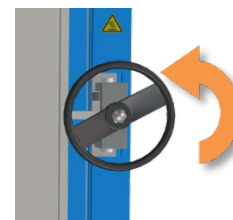

OPERATION

PUMP DOWN THE OVEN CHAMBER

Note: Perform a full pump down of the chamber for at least 30 minutes when first putting the oven into operation in a new location to verify the vacuum supply system integrity.



An operator must always be present to observe the vacuum gauge pressure display decreasing while the oven is drawing a vacuum to ensure the system is sealed. The oven door must be closed and latched prior to pumping down the chamber.

1. Push and release the Vacuum Start button on the unit control panel.

- The roughing pump will begin pumping down the chamber, and the vacuum gauge should show the chamber pressure decreasing.

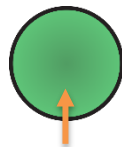

Push

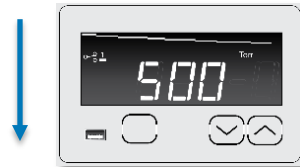

- The turbopump will automatically turn on after the chamber pressure level reaches 1 Torr.
- The pump down process may briefly pause as the vacuum system transitions to the turbopump.



End of Procedure

OPERATION

END THE PUMP DOWN PROCESS

This procedure isolates the chamber and shuts down the turbopump.

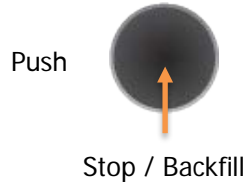

1. Push and Release the Stop/Backfill button.

- The oven will close the high vac gate valve, isolating the turbopump from the oven chamber.
- The turbopump will begin to spin down.
- The roughing pump will continue to pump down the foreline for 5 minutes, then close the foreline valve.

BACKFILL THE CHAMBER

Restores the oven chamber to room atmosphere. The turbopump must be shut down and the chamber isolated before initiating a backfill.



1. Press and hold the Stop / Backfill button.

- Hold the button down until the vacuum gauge shows the chamber pressure at or near room atmosphere pressure (approximately 760 Torr).



End of Procedure

OPERATION



SETTING A CONSTANT TEMPERATURE SETPOINT

Reminder: The manufacturer recommends fully pumping down the oven chamber before heating.

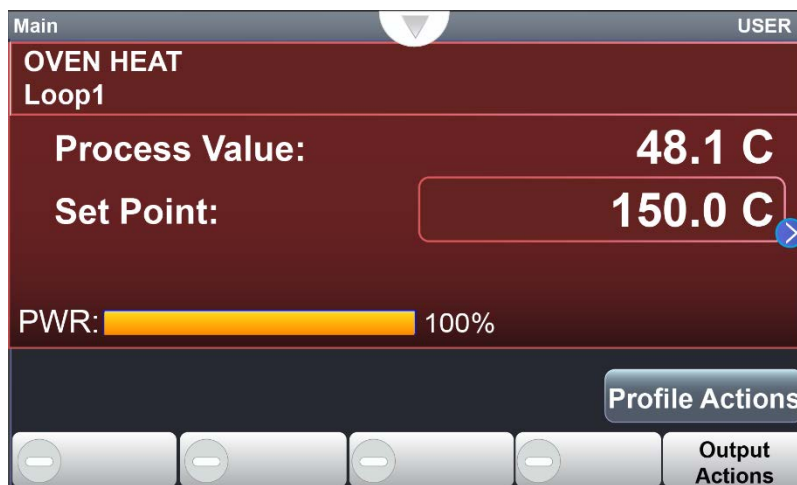
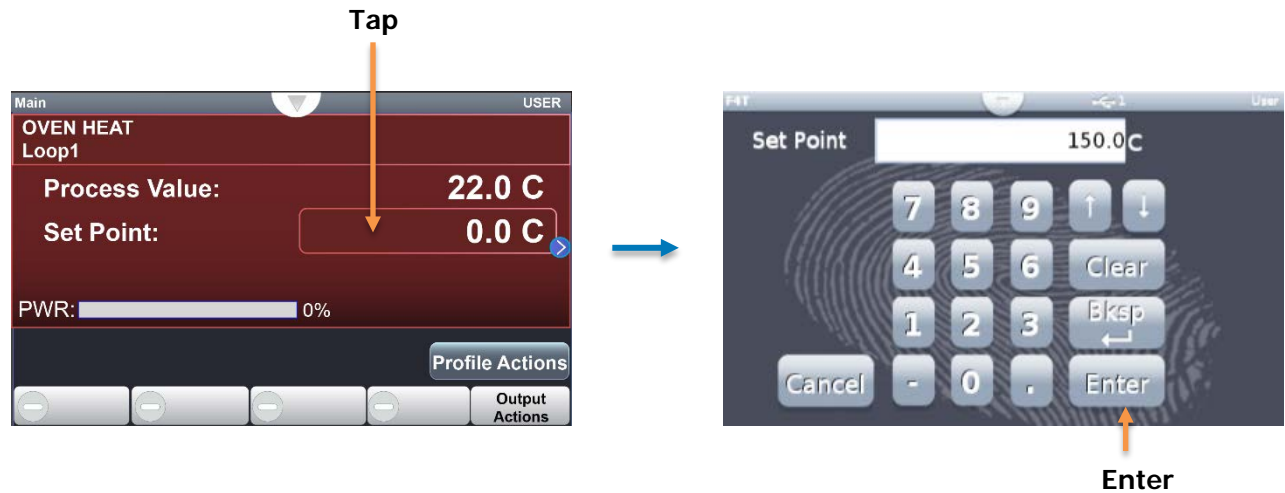

Oven heating to the new setpoint

1. Tap the Setpoint button on the Homepage oven temperature tab.
2. Enter a temperature setpoint.
3. To end constant temperature heating, enter a setpoint of 0.

HEATING PROFILES

Please see the *Profile Programming Manual* document for instructions on how to program automated temperature recipe profiles which is included with the oven and provides illustrated explanations for all major functions and programming steps.



You must be logged on to the controller to create or edit profiles. See page 46.

The manufacturer recommends exporting profiles as a backup using the USB-A port on the front of the control panel. See page 47.

Profile Reminder

The operator must manually push the Start Vacuum button to begin pumping down the oven chamber. The oven must be under vacuum prior to launching a profile.

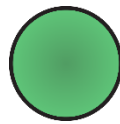

Start Vacuum

Profile Status Icons

Active (Running)	Paused	Completed	Terminated

OPERATION



OVEN LIMIT ACTIVE

Limit activations serve as a persistent, protective interruption of heating in the oven chamber. **Always identify and correct** the cause of an oven limit activation before restoring heating.

Oven Limit Heating Cutoff Active

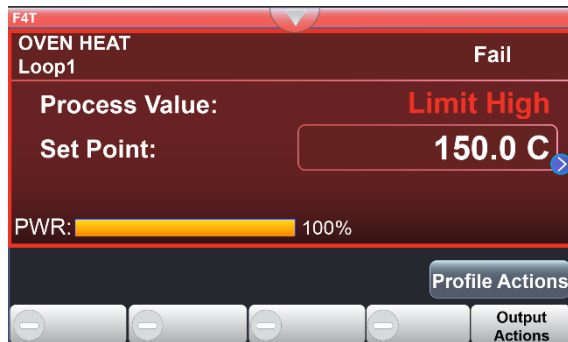

In this example, the chamber temperature exceeds both the Oven Limit Setting and the Temperature Setpoint.

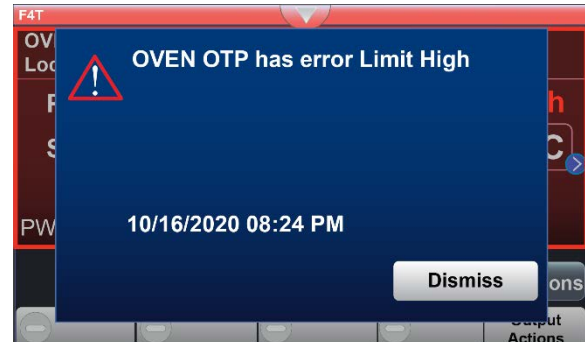

Note: Tapping Clear or Dismiss on the Alert Window does not end the Oven Limit. It only closes the window.



The red Alarm Light on the control panel illuminates steadily during an oven limit cutoff.

Note: The oven chamber **is not heating** in the example above. The power bar (PWR) indicates the oven controller is calling for power to the heating elements. However, the active Oven Limit system is routing power away from the elements.

Possible Limit Activation Causes

- Launching a heating profile with a temperature setpoint near to or exceeding the current Oven Limit setting.
- An external temperature source or a heat source in the oven chamber is pushing the oven temperature to or above the Limit setting.
- The temperature controller circuitry or sensor probe has failed, allowing uncontrolled heating in the chamber to meet or exceed the Oven Limit setting.

If you suspect a hardware failure or an ignition, even in the chamber, **turn off the oven and wait for the oven to cool to room temperature before backfilling the chamber.**

Clearing an Active Limit Cutoff

The oven shelving temperature must be below the Oven Limit setting before a Limit cutoff can be cleared (canceled).

Always identify and correct the cause of an Oven Limit activation before restoring heating.

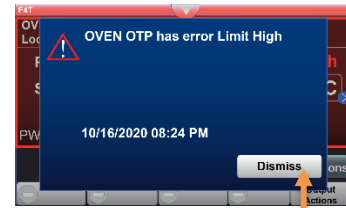

Alarm Message: This alert window appears the first time a button is tapped during a Limit cutoff. Tap Dismiss to close the message.

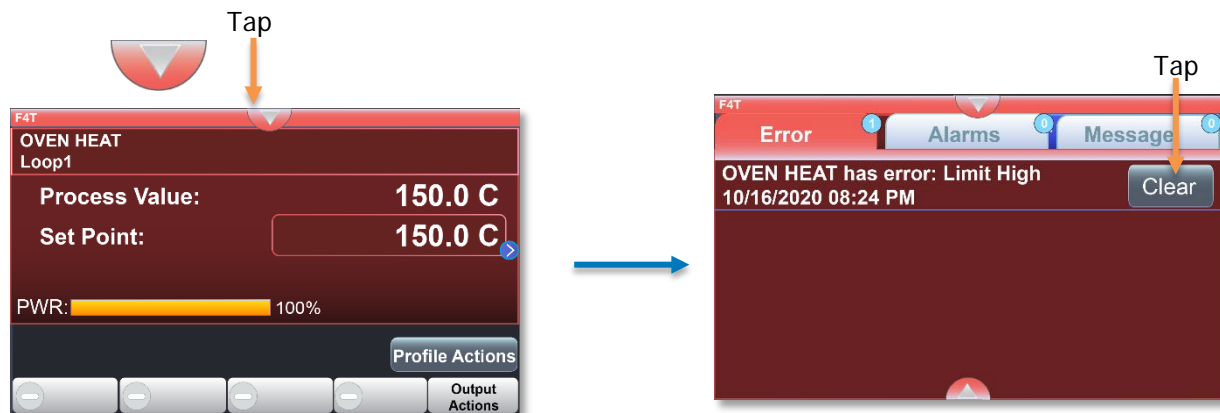

Oven temperature is below the High Limit setpoint.

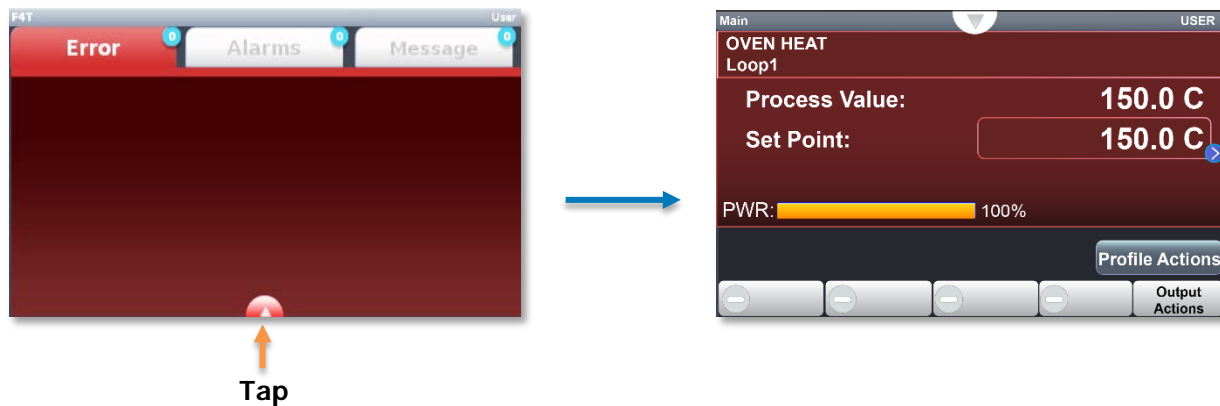

1. Tap the Down arrow on the top ribbon to bring up the Error screen.
2. Tap the Clear button on the Error screen to cancel the Oven Limit temperature cutoff.
3. Tap the Up arrow at the bottom of the screen to return to the homepage.

The red Alarm Light on the control panel will turn off automatically when the Oven Limit activation has been cleared.

DATA PORTS

Front of Unit

Control Panel USB A



The USB port located on the front control panel accesses the Main and High Limit controller and can be used for the following:

- Exporting and importing heating profiles from the controller
- Updating firmware

Back of the Unit

Ethernet



The ethernet port located on the back of the oven accesses the Main and High Limit controller. With the correct configurator software, the port can be used for the following:

- Downloading profiles and uploading profiles to the controller.
- Programming heating profiles in a desktop or laptop environment.
- Backing up and loading backed up oven configurations.

OVEN COOLDOWNS

The oven chamber is well insulated and requires a significant amount of time to cool down while remaining sealed.

- 6 hours may be required to cool down from 150°C to 100°C.
- 16 hours may be needed for the oven to return to room temperature cooling from 150°C.
- Backfilling the oven with N₂ does not significantly increase the rate of cooling.

Introducing free atmosphere into the oven chamber at temperatures above 100°C risks oxidizing chamber surfaces.

OPERATOR MAINTENANCE

Warning: Disconnect the unit from its power supply prior to maintenance or service.

Avertissement: Avant d'effectuer toute maintenance ou entretien de cet appareil, débrancher le cordon secteur de la source d'alimentation.



CLEANING

If a hazardous material or substance has spilled in the unit, immediately initiate your site Hazardous Material Spill Containment protocol. Contact your local Site Safety Officer and follow instructions per the site policy and procedures.

- **Do not** use spray-on cleaners or disinfectants. These can leak through openings and coat electrical components.
- **Do not** use cleaners or disinfectants that contain solvents capable of harming paint coatings or stainless-steel surfaces. **Do not use chlorine-based bleaches or abrasives, these will damage the chamber liner.**
- Consult with the manufacturer or their agent if you have any doubts about the compatibility of decontamination or cleaning agents with the parts of the equipment or with material contained in it.

Warning: Exercise caution if cleaning the unit with alcohol or flammable cleaners. Always allow the unit to cool down to room temperature prior to cleaning and make sure all cleaning agents have evaporated or otherwise been completely removed prior to putting the unit back into service.

Avertissement: Soyez prudent lorsque vous nettoyez l'appareil avec de l'alcool ou des produits de nettoyage inflammables. Laissez toujours refroidir l'appareil à la température ambiante avant le nettoyage et assurez-vous que tous les produits de nettoyage se sont évaporés ou ont été complètement enlevés avant de remettre l'appareil en service.



Oven Chamber Cleaning Guidelines

1. Remove any removable chamber accessory items such as shelving if present.
2. Use 99% isopropyl alcohol to clean chamber surfaces and shelving. Apply using lint-free wipes.
3. Take special care when cleaning around temperature sensor probes. Do not clean the probes.
4. Clean all removable accessories and components.
5. Verify the cleaning alcohol has evaporated completely from all chamber surfaces and accessories prior to reconnecting the unit to its power source.

MAINTAINING ATMOSPHERIC INTEGRITY

Periodically, inspect the door latch, trim, catch, and gasket for signs of deterioration. Failure to maintain the integrity of the door system shortens the lifespan of the unit.

GASKETS

The door gasket is a low wear item. It typically only needs to be replaced due to being cut or nicked. The risk of this type of damage can be significantly reduced by opening the door to 130°, keeping it well out of the way of shelves or sample trays being removed from or inserted into the chamber.

Replacement Procedure: The manufacturer recommends having a rubber mallet and exam gloves on hand to perform this procedure. Cover the mallet head with a clean plastic bag to help reduce contamination of the door. Wearing exam gloves likewise reduces the chance of contaminating the chamber door interior.

1. Remove the old gasket by pulling it out of the gasket well in the door.
2. Insert a few centimeters (inches) of the narrow side of the replacement gasket into the gasket well on the top of the door.
3. Insert a few centimeters (inches) of the gasket's narrow side gasket into the well on the bottom of the door.
4. Insert a few centimeters (inches) of the narrow side of the gasket into the well on the left side, then on the right side of the door.
5. Continue around the door in this fashion, alternating sides.
 - a. The rubber mallet can be used to help seat the gasket. Use moderate strokes.

ELECTRICAL COMPONENTS

Electrical components do not require maintenance. If the oven fails to operate as specified, please contact your distributor or [Customer Support](#) for assistance.

STORAGE

To prepare the unit for storage, remove all shelves, dry the chamber completely, and disconnect the power supply. Verify that the door is positively locked in the closed position.

UNIT SPECIFICATIONS

This oven is a 220 – 240 volt unit. Please refer to the oven data plate for individual electrical specifications.

Technical data specified applies to units with standard equipment at an ambient temperature of 25°C and at nominal voltage. The temperatures specified are determined in accordance with factory standards following DIN 12880 respecting the recommended wall clearances of 10% of the height, width, and depth of the inner chamber. All indications are average values, typical for units produced in the series. We reserve the right to alter technical specifications at all times.

WEIGHTS

Model	Shipping Weight
SVO-10-T	1679 lb / 762 kg
SVO-5-T	1160 lb / 526 kg

DIMENSIONS

Inches

Model	Exterior W × D × H	Interior W × D × H
SVO-10-T	38.7 x 52.9 x 75.8	28.8 x 26.0 x 24.5
SVO-5-T	28.8 x 51.9 x 69.2 in	18.0 x 26.0 x 18.0

Millimeters

Model	Exterior W × D × H	Interior W × D × H
SVO-10-T	983 x 1343 x 1925 mm	730 x 660 x 622 mm
SVO-5-T	732 x 1318 x 1758 mm	457 x 660 x 457 mm

CAPACITY

Model	Cubic Feet	Liters
SVO-10-T	10.60	300.0
SVO-5-T	4.88	138.0

SPECIFICATIONS

SHELF CAPACITY BY WEIGHT

Model	Per Shelf	Maximum Total Load	Max. No. Shelves
SVO-5-T	50.0 lb / 22.7 kg*	200.0 lb / 90.7 kg**	3 Shelves
SVO-10-T	50.0 lb / 22.7 kg*	200.0 lb / 90.7 kg**	8 Shelves

*50.0 lb / 22.7 kg with weight evenly distributed across the shelf.

**200.0 lb / 90.7 kg total load in the chamber. Exceeding this limit risks damaging the chamber liner.

VACUUM

Operational Vacuum Range

Torr	mbar
1×10^{-6}	1.3×10^{-6}

Vacuum Display Range

Torr	mbar
3.8×10^{-10}	5×10^{-10}

TEMPERATURE

Range, Stability, and Uniformity

Model	Range	Stability	Uniformity
SVO-10-T	Ambient +10° to 220°C	± 0.2°C @ All Temps	±6% of Setpoint
SVO-5-T	Ambient +10° to 220°C	± 0.2°C @ All Temps	±6% of Setpoint

Time to Temperature

Model	Heat up to 80°	Heat up to 150°C	Heat up to 220°C
SVO-10-T	N/A	N/A	N/A
SVO-5-T	68 Minutes	125 Minutes	177 Minutes





SPECIFICATIONS

POWER

Model	AC Voltage	Amperage	Frequency
SVO-10-T	220 – 240	30	50/60 Hz
SVO-5-T	220 – 240	20	50/60 Hz

This page left blank.

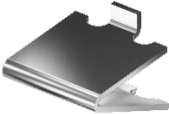
REPLACEMENT PARTS LIST

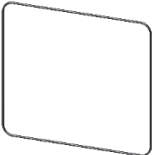
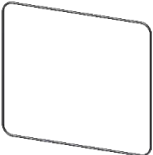
Description	Parts Number	Description	Parts Number
Adjustable Leveling Feet	 2700506	Shelf, SVO-10-T	 5221059
Shelf Clip, Individual (1)	 1250510	Shelf, SVO-5-T	 5221137
Viton Door Gasket, SVO-5-T 79.5" (2019 mm)	 3450789	Viton Door Gasket, SVO-10-T 110.5" (2807 mm)	 3450755

Ordering Parts and Consumables

Parts may be ordered from Cascade TEK by calling 1-888-835-9250. Please have the **model**, **part**, and **serial** numbers and **Part ID** of the unit ready, as Customer Support will need this information to match your unit to its correct part.

CASCADE™

TEK

Cascade TEK Solutions LLC
300 N. 26th Ave.
Cornelius, OR 97113
USA

support@cascadetek.com
cascadetek.com
1-888-835-9250
1-971-371-4096

